

# FRONT SIDE PIPE

Accessory Name	Parts Number	Application Model	Issue Date	Publication No.	FRT
FRONT SIDE PIPE	08P70-MLN-EQ0	CRF1100A4/D4/AL4/ DL4	2023.8	MII	0.8 H
GUARD ATTACHMENT	08P75-MKS-E00				

### Introduction







ALL INFORMATION, ILLUSTRATIONS, DIRECTIONS AND SPECIFICATIONS INCLUDED IN THIS PUBLICATION ARE BASED ON THE LATEST PRODUCT INFORMATION AVAILABLE AT THE TIME OF APPROVAL FOR PRINTING. Honda Motor Co., Ltd. RESERVES THE RIGHT TO MAKE CHANGES AT ANY TIME WITHOUT NOTICE AND WITHOUT INCURRING ANY OBLIGATION WHATSOEVER. NO PART OF THIS PUBLICATION MAY BE REPRODUCED WITHOUT WRITTEN PERMISSION. THIS MANUAL IS WRITTEN FOR PERSONS WHO HAVE ACQUIRED BASIC KNOWLEDGE OF MAINTENANCE ON Honda MOTORCYCLES, MOTOR SCOOTERS OR ATVS.

Honda Dealer:  
Please give a copy of these instructions to your customer.

Customer:  
Because it requires specialized knowledge and special tools and equipment, it is recommended to install it at a dealer with qualified automobile maintenance.

### How To Read These Symbols

Your safety, and the safety of others, is very important. To help you make informed decisions we have provided safety messages and other information throughout this manual.

-  **WARNING** You CAN be KILLED or SERIOUSLY HURT if you don't follow instructions.
-  **CAUTION** You CAN be HURT if you don't follow instructions.
-  **NOTICE** The purpose of this message is to help prevent damage to your vehicle, other property, or the environment.
-  **NOTE** Things you want to know, things that are useful to know.
-  Follow the instructions of the Service Manual.
-  Follow the other symbol instructions of the "Installation Instructions BASIC".

### Instruction Other Symbols

The symbols used throughout this instructions show specific service procedures. Refer to "Installation Instructions BASIC" for description of each symbol.

## INFORMATION

### CAUTION

- To prevent burns, allow the engine, exhaust system, radiator, etc., to cool before installing the accessory.

### NOTICE

- Take care not to damage the painted surfaces of the motorcycle.

### NOTE:

- Disconnect the negative (–) cable from the battery before installing this accessory.
- Reinstall the removed parts on the motorcycle and make sure that the wires and harnesses are not pinched.
- After reconnecting the battery, refer to the motorcycle Owner's Manual and set the meter.
- After this accessory installation, check the lights (e.g. right/left turn signal lights and brake lights) for proper operation.
- Although the illustration is of CRF1100D, use the same procedures for other models.
- Save all removed parts unless otherwise indicated.

## TORQUE INFORMATION

Refer to the Service Manual for the torque values including standard torque of the removed parts. ()

# PARTS LIST

When the instruction manual and installation instructions are included in this kit, be sure to give them to the customer.

## <FRONT SIDE PIPE>

Component	No.	Parts Name	Qty	Parts No.
	(1)	Right front side pipe	1	-
	(2)	Left front side pipe	1	-
	(3)	Front side center pipe	1	-
	(4)	Front side center pipe stay	1	-
	(5)	Front side pipe spacer	2	-
	(6)	Grommet	2	-
	(7)	Exhaust pipe gasket	2	18291-MM8-880
	(8)	8 mm flange cap nut	2	90208-438-000
	(9)	6.2 x 12 mm collar	2	90501-425-000
	(10)	6 mm flange nut	2	94050-06080
	(11)	8 mm flange nut	1	94050-08070
	(12)	6 x 30 mm SH flange bolt	2	-
	(13)	8 x 24 mm SH flange bolt	2	-
	(14)	8 x 32 mm flange bolt	2	96400-08032-08
	(15)	Washer	2	90406-KV3-780

## <GUARD ATTACHMENT>

Component	No.	Parts Name	Qty	Parts No.
	(16)	Right guard bracket	1	-
	(17)	Left guard bracket	1	-
	(18)	Engine guard spacer	2	08P18-MKS-E00*
	(19)	8 x 95 mm flange bolt	2	-
	(20)	8 mm flange nut	2	90305-MKS-E00

\*: ED type can be ordered.

# INSTALLATION

1. Refer to the Service Manual for motorcycle, remove the motorcycle parts as shown, and disconnect the negative (-) cable from the battery. (📖)

<LEFT SIDE>

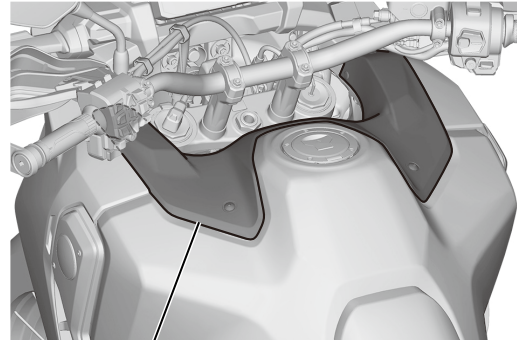
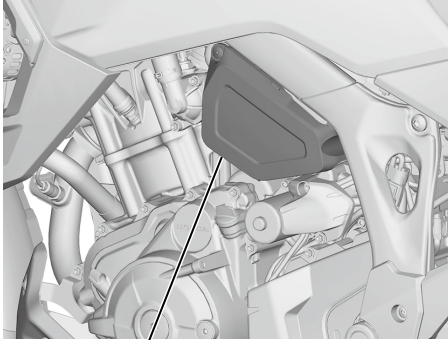

<RIGHT SIDE>

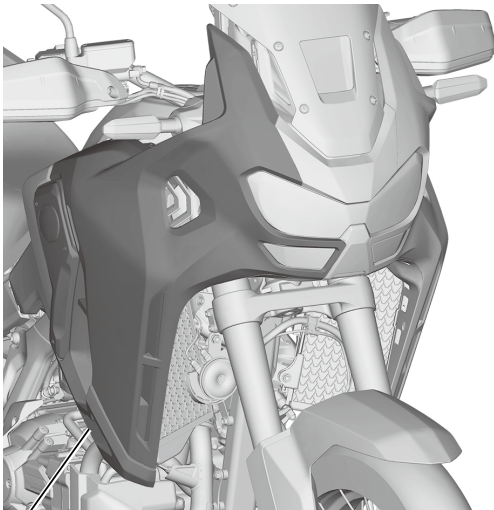

Right side only.

<RIGHT SIDE>

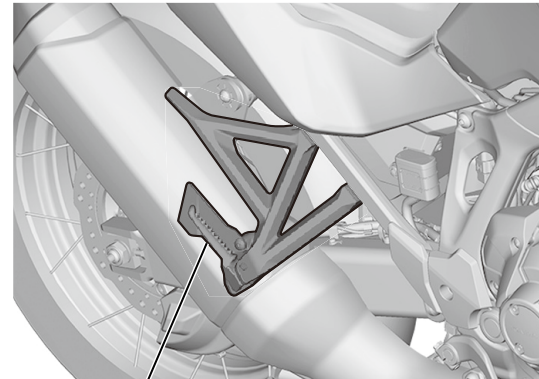

INSTALLATION IMAGE

<RIGHT SIDE>

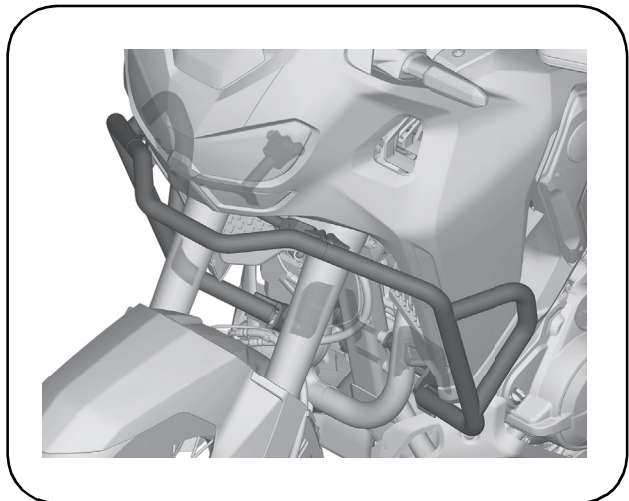
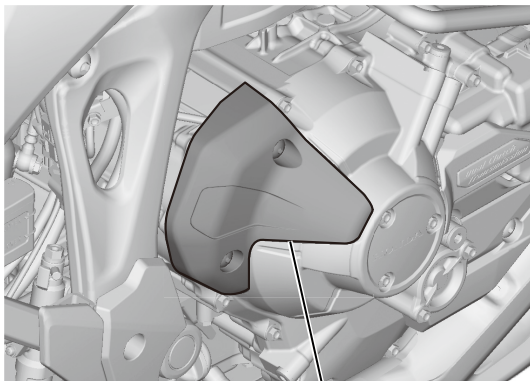

2. Disconnect the motorcycle's connectors as shown.

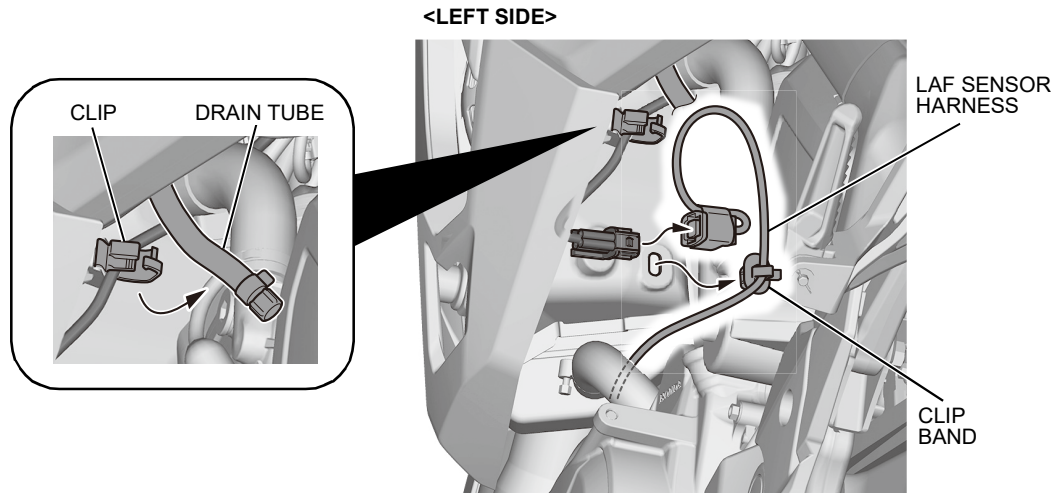

3. Disconnect the motorcycle's connectors as shown.

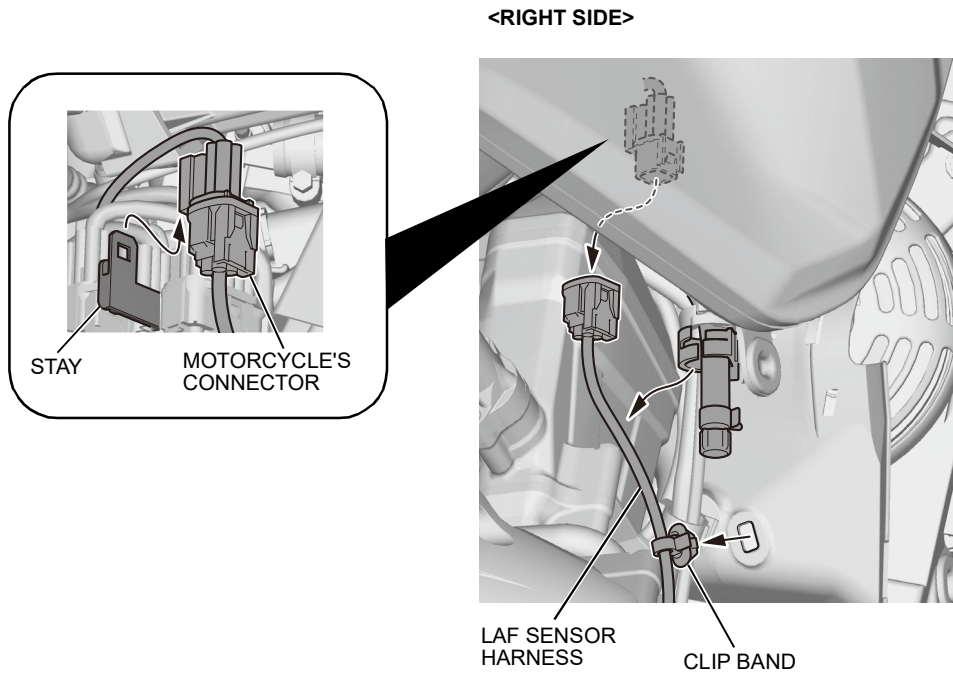

4. Disconnect the motorcycle's connectors as shown.

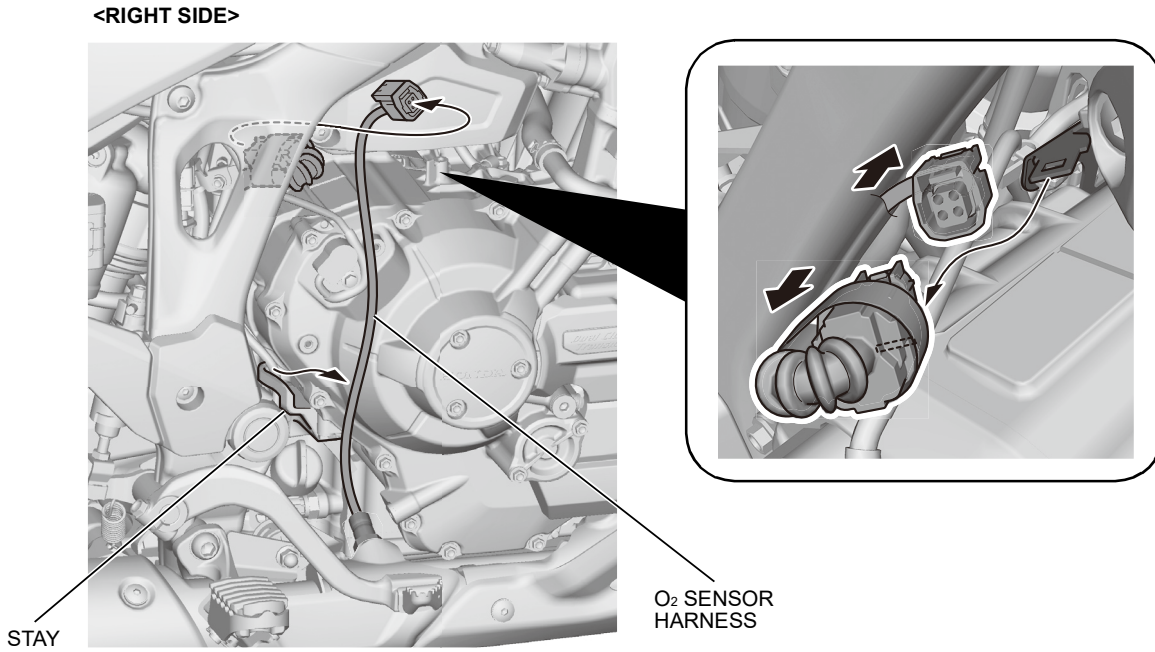

5. Remove the motorcycle parts as shown.

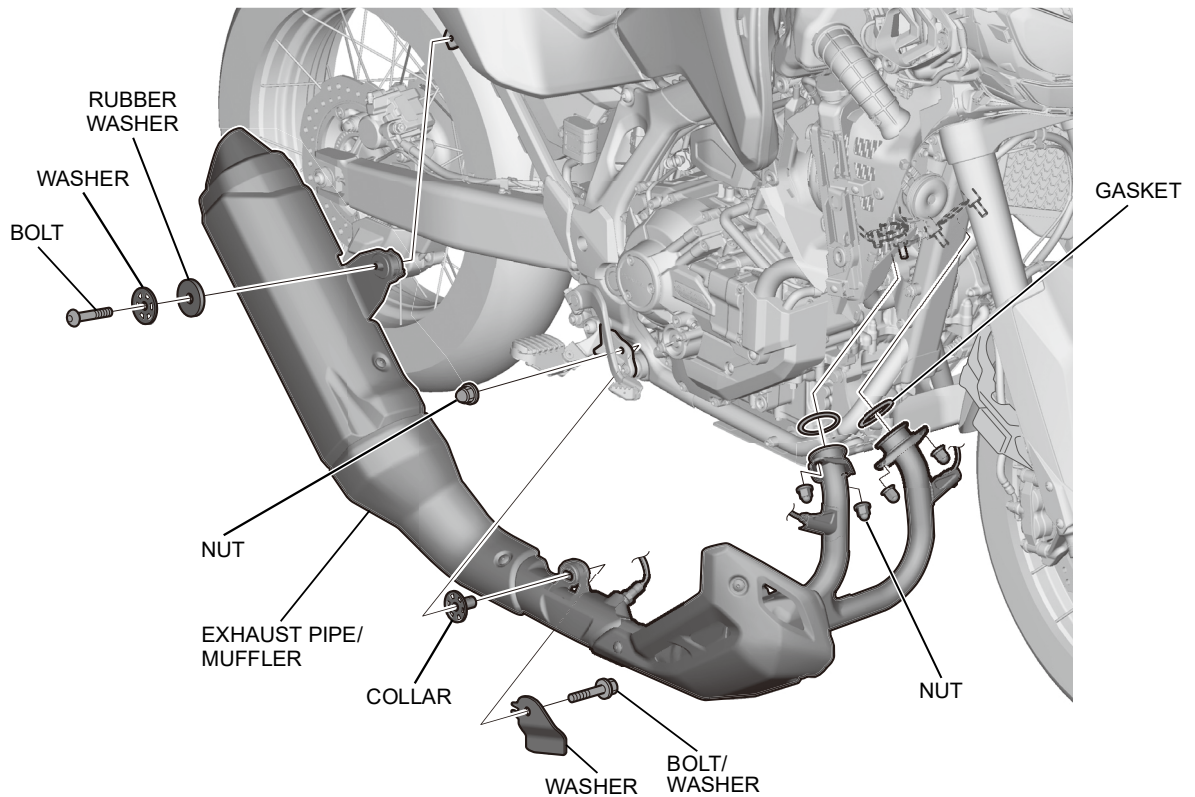

6. Remove the motorcycle parts as shown.

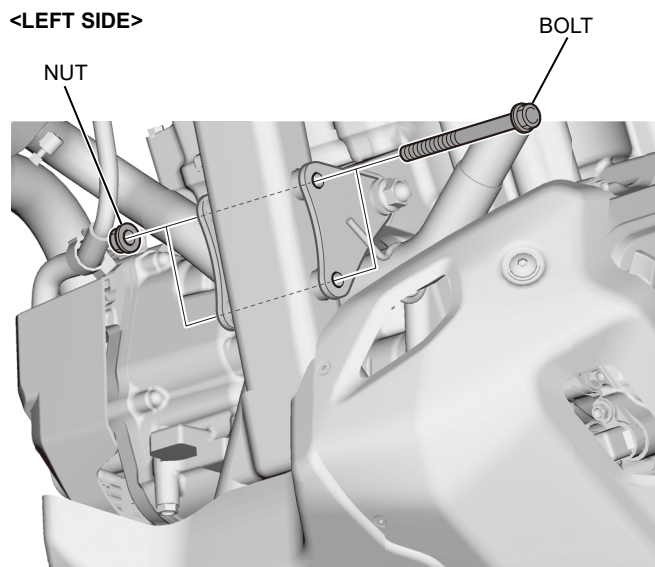

7. Install as shown.

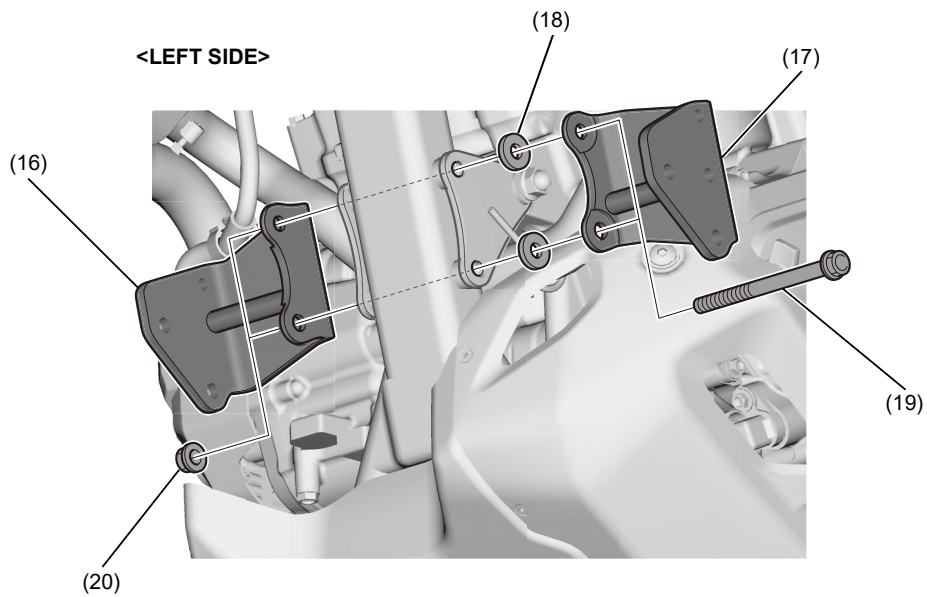

8. Install the exhaust pipe/muffler in the reverse order of removal.
- Use the new exhaust pipe gaskets in this kit.

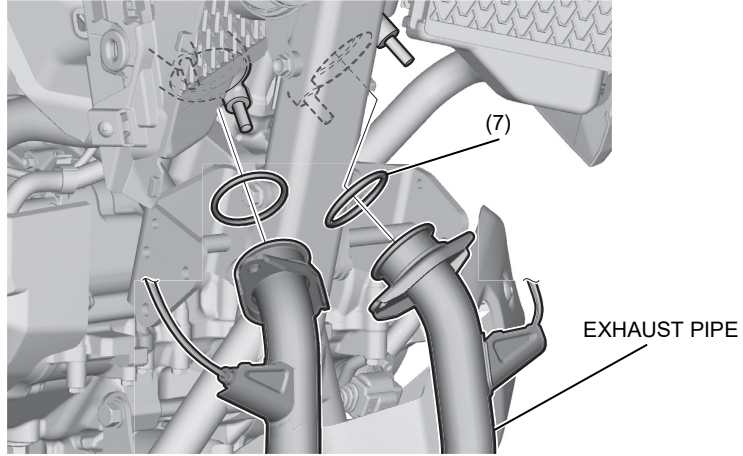

9. Install the right middle cowl, left drain tube and disconnected connectors in the reverse order of removal.

10. Remove the motorcycle parts as shown.

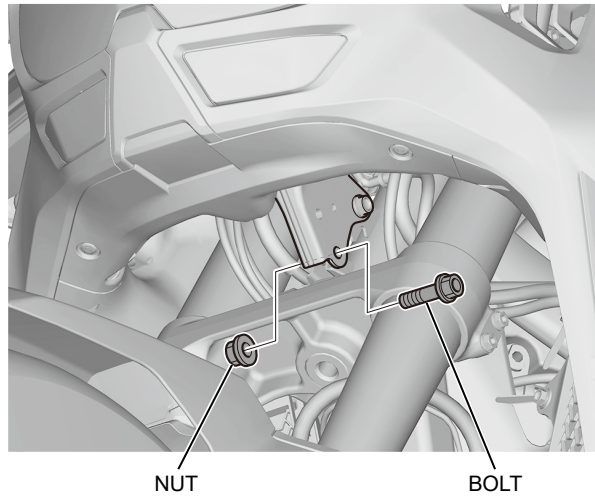

11. Install as shown.

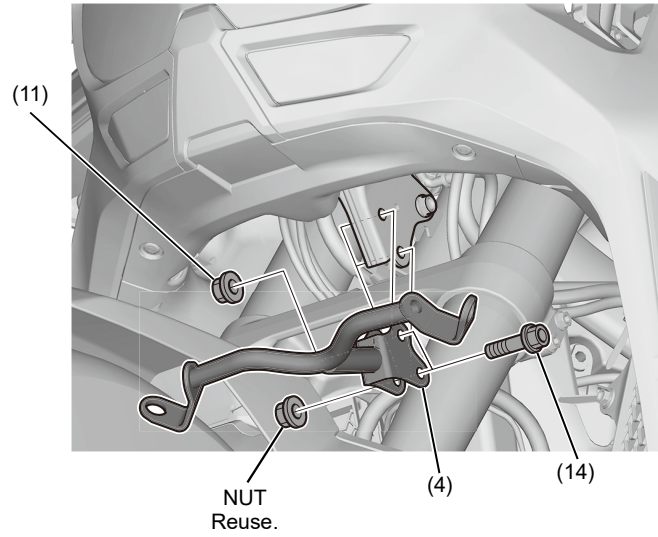

12. Install as shown.

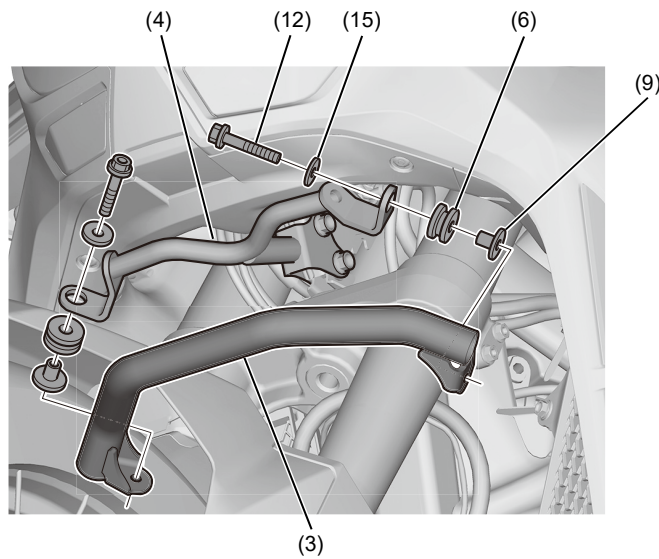



13. Loosely install as shown.  
 • Repeat on the right side.

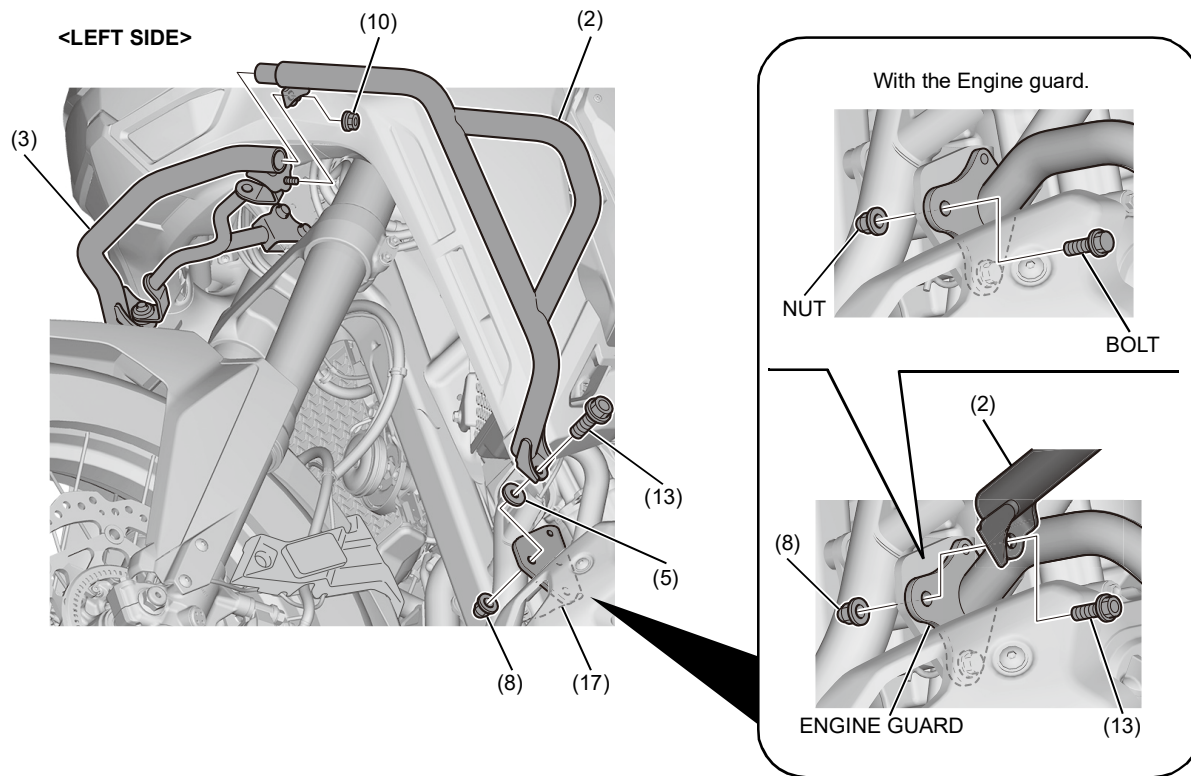

14. Tighten all loosely installed parts securely.

15. Install the motorcycle's parts in the reverse order of removal.  
 • Confirm that any harness is not caught or too tight.